

JVC

Instructions

MICRO HD CAMERA

DZ-VCA3U

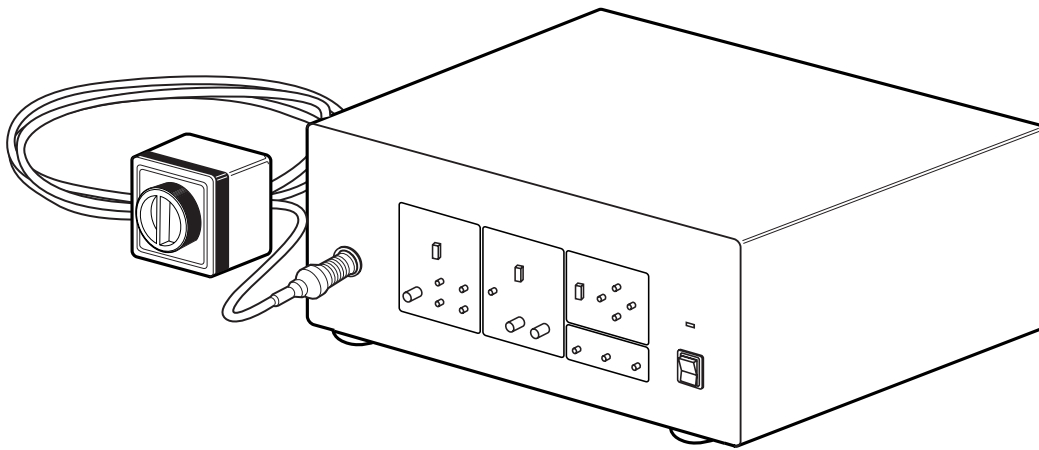

Contents

Applications	3
Precautions on installing medical electrical equipment (Safety and hazard prevention)	3
Safety precautions	4
Important product safety instructions	5
Precautions	7
Safety precautions	7
Handling precautions	7
Inspection and maintenance	8
Camera Head Section	8
Phenomena peculiar to CCDs	8
Connections	9
Names of parts and their functions	10
Camera control unit (front panel)	10
Camera control unit (rear panel)	11
Camera head	11
Output level control section	12
White balance control section	13
Mode control section	14
Menu control section	14
Basic operation	17
White balance adjustment (auto)	17
White balance adjustment (manual)	17
Operation of Micro HD camera	18
System operation	18
Connector	19
Specifications	20
Optional Equipments	22
Technical and service assistance	22
Warranty and after-sales-service	23
Warranty record confirmation and safekeeping	23

Standard construction

Please check the following accessories before use.

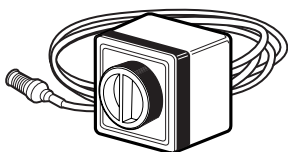

Camera head

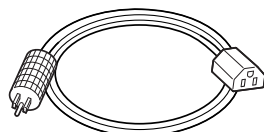

AC Inlet cable

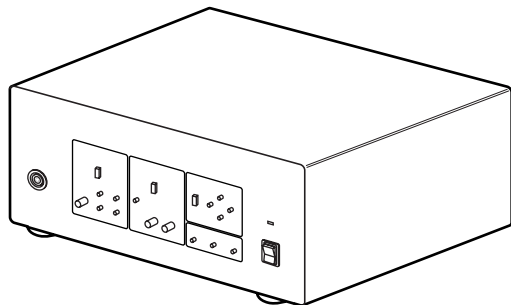

Camera control unit

Feature

Thank you for purchasing the
DZ-VCA3U MICRO HD CAMERA.

- **Compact, lightweight design**

Thanks to the incorporation of 1/3-inch CCDs, the camera head's outer dimensions have been reduced to a compact 44 (W) x 51.4 (H) x 57.7 (D) mm and its weight to only 100g.

- **High resolution**

A total of three VGA 1/3-inch CCDs are used (for each R, G and B). With digital signal processing, this camera is able to produce extremely high horizontal resolution (750 TV lines) and vertical resolution (700 TV lines). The aspect ratio is 4:3.

- **System construction**

HDTV studio standard (compliant with ITU-R Rec.709) sync signals are used, allowing recorded picture to be played back with high picture quality when an HDTV VCR such as the W-VHS VCR is used.

- **Automatic sensitivity control**

The automatic sensitivity control combines automatic sensitivity control with ALC and electronic iris (ALC +EEI) to allow trouble-free shooting xh intensity.

- **Electronic shutter function**

A built-in 1/10000-sec. electronic shutter function allows capture and analysis of fast-moving subjects.

- **Flicker-free mode**

Greatly reduces the flickering caused by shooting under a fluorescent lamp in locations using 50-Hz cycles.

- **Colour bar generator**

A full colour bar generator is built in for easy system adjustment.

- **Automatic internal/external sync switching**

Useful for systematic operations, such as multicamera video processing, in combination with other devices.

- **2H contour provided as standard**

Contour compensation is performed both horizontally and vertically to assure sharp, clear pictures.

• JVC cannot be responsible for any loss or damage to recorded material in the event that the colour video camera, VCR, or video cassette malfunctions during recording.

Applications

Micro HD camera system can be used for following application; Endoscope operation in OR.

(This system should only be operated by doctors or authorized persons.)

Above application, the system can supply HD and SD signals to HD/SD monitor for display and to HD/SD VTR for recording/playback.

Electrical energy can perform many useful functions. But improper use can result in potential electrical shock or fire hazards. This product has been engineered and manufactured to assure your personal safety. In order not to defeat the built-in safeguards, observe the following basic rules for its installation, use and servicing.

Precautions on installing medical electrical equipment (Safety and hazard prevention)

For the safe use of this equipment, always follow the guidelines described below.

Power connection:

1. To prevent damage to the product, make sure that it is grounded properly and pay attention to its power polarization.
2. Operate your product only from the type of power source indicated on the product label. If you are not sure of the type of power supply to the hospital, consult your product dealer or the local power company. If your product is intended to operate from battery power or other sources, refer to the operating instructions.
3. Overloading
Do not overload wall outlets, extension cords, or integral convenience receptacles as this can result in a risk of fire or electric shock.
4. Power Cord Protection
Power supply cords should be routed so that they are not likely to be walked on or pinched by items placed upon or against them, paying particular attention to cords at plugs, convenience receptacles, and the point where they exit from the product.

For the safe use of this equipment, be absolutely sure to follow the guidelines below.

1. Leave installation of the Mobile Video Cart and the unit to a specially trained service persons.
2. Be absolutely sure to use the separately sold AA-V31U isolation transformer.
3. There are openings in the equipment. Fire or electric shock may result if liquid splashes inside one of these openings. To prevent any possible problems, please set the cart in a reasonable position and use carefully.

- For medical use, please use the JVC Isolation Transformer, AA-V31U. The specifications for the AA-V31U is given on page 22.
- Do not use mobile cart when crossing a threshold or excessively thick carpet.
- Be extra careful when transporting this product with mobile cart. Sudden stops, excessive force, and travelling on uneven surfaces may cause the product and cart to topple.

ATTENTION:

Follow and obey all warnings and instructions marked on your product and its operating instructions. For your safety, please read all the safety and operating instructions before you operate this product and keep this booklet for future reference.

Dear Customer,

Thank you for purchasing the MICRO HD CAMERA. Before use, please read the safety information and precautions contained in the following pages to ensure safe use of your new MICRO HD CAMERA.

Importer's name & address

J.P.C.: JVC PROFESSIONAL PRODUCTS COMPANY
1700 Valley Road, Wayne NJ 07470
TEL: (973) 317-5000
FAX: (973) 317-5030

Cart information

- (1) Cart should meet with UL2601-1.
- (2) Load capacity(Top)
 - Please chose a video cart which maximum load capacity is more than 45 kg.
- (3) Two casters have brakes
 - When using a mobile cart in OR, two brakes should be set for safety after setting the position of the cart.
- (4) Important notice 1
 - When using mobile video cart in OR, precautions to avoid crossing over the power cord of the cart.
 - When using a mobile cart in OR, precaution to avoid power cord of the cart to be caught by foot or caster of the cart should be taken.
- (5) Important notice 2
 - When mounting monitor on a mobile cart, we strongly recommend the use of monitor strap for safety.

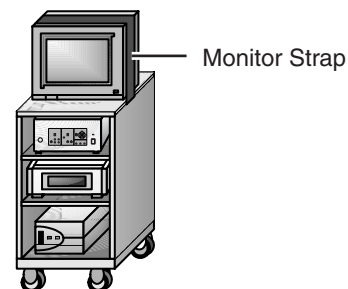

An example of using medical video cart.

Safety precautions

Please Read Before Use

WARNING:
TO PREVENT FIRE OR SHOCK HAZARD, DO NOT EXPOSE THIS UNIT TO RAIN OR MOISTURE.

CAUTION:
This MICRO HD CAMERA should be used with a power supply of AC 120 V \sim , 60 Hz only.
To prevent electric shocks and fire hazards, DO NOT use any other power supply.

WARNING:
This camera head with camera cable and camera control unit are not sterilized.
Before using, please conduct the sterilization according to page 6.

WARNING:
Use the endoscope in accordance with IEC60601-1 and IEC60601-2-18.

WARNING:
RISK OF ELECTRIC SHOCK.
DO NOT OPEN THE CABINET.

WARNING:
The use of ACCESSORY equipment not complying with the equivalent safety requirements of this equipment may lead to a reduced level of safety with the resulting system. Consideration relating to the choice of accessories shall include:

- use of the accessory in the vicinity of the patient
- evidence that the safety of the accessory has been certified in accordance with the appropriate IEC 60601-1 and/or IEC 60601-1-1 harmonized national standard.

WARNING:
The Monitor and VCR must be connected to the Isolation Transformer which power supply is AC 120 V of a hospital wall outlet.
To prevent electric shock and fire hazard, DO NOT plug directly into a hospital wall outlet.

WARNING:
In order to avoid the risk of fire and shock hazards, please use only the equipment specified in this instruction manual.

Important product safety instructions

INSTALLATION AND DISPOSAL

1. Grounding or Polarization

Precautions should be taken so that the grounding or polarization of an appliance is not defeated.

2. Power Sources

Operate your product only from the type of power source indicated on the marking label. If you are not sure of the type of power supply to hospital, consult your product dealer or local power company. If your product is intended to operate from battery power, or other sources, refer to the operating instructions.

3. Overloading

Do not overload wall outlets, extension cords, or integral convenience receptacles as this can result in a risk of fire or electric shock.

4. Power Cord Protection

Power supply cords should be routed so that they are not likely to be walked on or pinched by items placed upon or against them, paying particular attention to cords at plugs, convenience receptacles, and the point where they exit from the product.

5. Ventilation

Slots and openings in the cabinet are provided for ventilation. To ensure reliable operation of the product and to protect it from overheating, these openings must not be blocked or covered.

- Do not block the openings by placing the product on a bed, sofa, rug or other similar surface.
- Do not place the product in a built-in installation such as a bookcase or rack unless proper ventilation is provided or the manufacturer's instructions have been adhered to.

6. Storage Location

Do not store this product in a humid location, such as near a window or an air conditioner, nor in a hot location, such as near a heater.

7. Disposing of the Product

Always sterilize this product before disposing of it. (See page 6.)

When discarding equipment, environmental problems must be considered and the local rules or laws governing the disposal must be followed strictly.

USE

1. Accessories

To avoid personal injury:

- Do not place this product on an unstable cart, stand, tripod, bracket, or table. It may fall, causing serious injury to a child or adult, and serious damage to the product.
- Use only with a cart, stand, tripod, bracket, or table recommended by the manufacturer or sold with the product.
- Use a mounting accessory recommended by the manufacturer and follow the manufacturer's instructions for any mounting of the product.
- Do not try to roll a cart with small casters across thresholds or deep-pile carpets.

2. Product and Cart Combination

A product and cart combination should be moved with care. Quick stops, excessive force, and uneven surfaces may cause the product and cart combination to overturn.

PORTABLE CART WARNING
(Symbol provided by RETAC)



3. Water and Moisture

Do not use this product near water—for example, near a bath tub, wash bowl, kitchen sink or laundry tub, in a wet basement, or near a swimming pool and the like.

4. Object and Liquid Entry

Never push objects of any kind into this product through openings as they may touch dangerous voltage points or short-out parts that could result in a fire or electric shock. Never spill liquid of any kind on the product.

5. Attachments

Do not use attachments not recommended by the manufacturer of this product as they may cause hazards.

6. Cleaning

Unplug this product from the wall outlet before cleaning.

Do not use liquid cleaners or aerosol cleaners. Use a damp cloth for cleaning.

7. Sterilization

Before using the endoscope, always be sure to sterilize the Endoscope adapter, the HD camera head, and the camera cable.

8. Heat

The product should be situated away from heat sources such as radiators, heat registers, stoves, or other products (including amplifiers) that produce heat.

Important product safety instructions (Continued)

SERVICING

1. Servicing

If your product is not operating correctly or exhibits a marked change in performance and you are unable to restore normal operation by following the detailed procedure in its operating instructions, do not attempt to service it yourself as opening or removing covers may expose you to dangerous voltage or other hazards.

Refer all servicing to qualified service personnel.

Note:

Before returning the camera head, endoscope adapter, be sure to sterilize the camera head with cable and endoscope.

2. Damage Requiring Service

Unplug this product from the wall outlet and refer servicing to qualified service personnel under the following conditions:

- a. When the power supply cord or plug is damaged.
- b. If liquid has been spilled, or objects have fallen into the product.
- c. If the product has been exposed to rain or water.
- d. If the product does not operate normally by following the operating instructions. Adjust only those controls that are covered by the operating instructions as an improper adjustment of other controls may result in damage and will often require extensive work by a qualified technician to restore the product to its normal operation.
- e. If the product has been dropped or damaged in any way.
- f. When the product exhibits a distinct change in performance—this indicates a need for service.

3. Replacement Parts

When replacement parts are required, be sure the service technician has used replacement parts specified by the manufacturer or have the same characteristics as the original part. Unauthorized substitutions may result in fire, electric shock or other hazards.

4. Safety Check

Upon completion of any service or repairs to this product, ask the service technician to perform safety checks to determine that the product is in safe operating condition.

5. Operational Life of the Product

Regular maintenance and inspection is essential for ensuring safe and long-lasting operation of this product.

Inspect and maintain the product before and after use, and also request the specialist for maintenance at least once a year.

STERILIZATION:

The camera head with camera cable and video adapter can be sterilized with ethylene oxide (EO) and STERAD® (50, 100, 100S, 500) supplied by Johnson & Johnson Medical Inc., and Steris System 1 supplied by STERIS Corporation.

Ethylene oxide

Desorbition time for ethylene oxide after using aerator:

more than 18 hours

Desorbition time is based on the following sterilization parameters:

Ethylene oxide gas : Ethylene oxide 20%
and CO₂ 80%

Temperature : 40° to 60°C

Humidity : 40 to 60% RH

Ethylene oxide density : 500 to 600 mg/l

Desorbition method : Aeration

Aerator : 50°C and more than 18
hours

(In room temperature it is
required more than 48 H)

Sterad (H₂O₂ plasma)

In the case of using STERAD®, please follow the instruction of the manufacturer. Because of using Sterad many times, some cosmetic changes can be observed. However, the functions of HD camera system are not affected by those.

Steris System 1

In the case of using Steris Process, please follow the instruction of the manufacturer.

Because of using Steris Process many times, some cosmetic change can be observed. However, the functions of HD camera system are not affected by those.

Notes:

- Never sterilize camera head without endoscope adapter and connector cap.
- Deterioration of camera cable
Sterilization may cause deterioration of rubber part of camera cable.
Depending on the frequency of use, however at least once a year, an expert must check the device.
- When connecting the endoscope adapter to the camera head, align it to the screw of C mount on the camera head and turn the endoscope adapter clockwise to tighten it. The O ring of the adapter makes the system waterproof. The connector of the camera cable should be connected with cap.
Sterilize the system under the above situation.

Precautions

Safety precautions

- Do not damage or modify the power cable. Doing so could result in current leakage or electric shock.
- To protect the camera and avoid electric shock hazards, always disconnect the power cord of the camera control unit from the AC outlet when the camera is not in use for an extended period.
- Make sure that no flammable objects, water, or bits of metal get inside the unit. These could damage the unit or cause a malfunction.
- Whenever an anomaly (unusual noise, smell or smoke) occurs, immediately turn off the main unit's power, unplug the power cord, and consult your nearest JVC dealer.
- Never use digital equipment such as portable telephones or video cameras when using this unit as this may cause a malfunction.

Handling precautions

- For extended product life, avoid using and storing the unit in places subject to the following conditions:
 - extreme heat or cold
 - vibrations
 - dust or soil
 - high humidity
 - strong noise source
- The environmental temperature under which this unit can be operated is limited by the image sensing device. Use this unit within an environmental temperature range of from +5°C to +35°C (41°F to 95°F).
- Avoid strong vibrations or violent shocks to this unit during installation or transportation.
- If the power voltage is too high or too low, the service life of this unit may be decreased and optimum performance may not be assured.
- Do not plug in or unplug the camera cable connector while this unit turned on. Doing so could cause a malfunction.
- Wipe the cabinet clean with a soft cloth. To remove excessive dirt, clean the unit with a soft cloth dipped in a mild detergent diluted with water. Wring out any excess liquid before wiping. Use a dry cloth to dry the unit. Do not use a volatile liquid such as benzene, thinner or alcohol. These may damage the cabinet surface or the coating.
- Be sure to use this unit in combination with the components described in "Micro HD camera system component" on page 9. Do not use this unit near strong radio sources such as a radio, TV or portable phone, or near devices that produce a strong electromagnetic field such as a transformer or motor as this may generate noise in the picture or cause changes in image colour.
- Do not bring an electronic scalpel or other sources of electronic noise near this product. Doing so can interfere with the monitor display.
- When using a wireless microphone and receiver with this unit, check them beforehand to ensure that noise does not enter the wireless receiver.



If a problem develops concerning the operation of this product while it is being employed as an endoscopy system during surgery, etc., take the appropriate action as described below:

- Problem with the endoscope
The lamp for the light source may have been burned out. Please read the operating manual for details on replacing the lamp.
 - Problem with the Micro HD Camera
If a problem with the operation of the monitor screen develops and the normal screen is no longer displayed, turn the power off and then turn the power back on again after 5 seconds later.
 - After use, immediately remove the camera cable from the CCU and connect the cap to the connector. Align the cap to the connector and turn the cap clockwise to connect it firmly.
-
- Check the following items before using the product.
 - (1) Make sure that the product is grounded properly.
 - (2) Make sure that all of the cords are connected properly.
 - (3) When using this product in conjunction with other equipment, consult a specialist in order to minimize any risk of misoperation or misdiagnosis.
 - (4) Make sure that the product has been sterilized.
 - Pay attention to the following while using the product.
 - (1) Make sure that the patient is not experiencing any distress.
 - (2) Make sure that all of the equipment is operating correctly.
 - (3) Make sure that the patient does not touch the product.
 - Pay attention to the following after using the product.
 - (1) Following the prescribed procedure, return the product to its original state before it was used, and then turn the power off.
 - (2) When disconnecting the cords, do not pull on the cords with undue force.
 - (3) Storage location
 - Avoid locations where the product may get wet.
 - Avoid locations with extremes in air pressure, temperature, or humidity; poor ventilation; exposure to direct sunlight; high levels of dust; high levels of chlorine or sulfur compounds.
 - Avoid storing the product on an unstable surface; for example, one that is on a slope or is exposed to vibration or physical shocks.
 - Avoid storing the product in a location that is used to store chemicals or where gases are present.
 - Clean the product, its accessories, and the cords so that they are ready for use the next time that they are needed.
 - If the product malfunctions, do not attempt to repair it yourself. Place a label on it that clearly indicates that it is "out of order" and contact a repair specialist.
 - Do not attempt to modify the product.
 - Equipment not suitable for use in the presence of a flammable anaesthetic mixture with air or oxygen or nitrous oxide.

Precautions (Continued)

Inspection and maintenance

1. The product and its components must be inspected regularly by a specialist. (The product should be inspected once a year).
2. When reusing the product after it has not been used for one month, check first if it operates normally and safely before you reuse.

Camera Head Section

1. Leave installation of the product to a specially trained service personnel.
2. Connect the optional endoscope adapter DZ-E3U or DZ-E33U to lens mount of camera head.
Remove the cap from the lens mount (when cap is connected to the lens mount), align the screws of lens mount and endoscope adapter and turn the lens mount clockwise to tighten it.

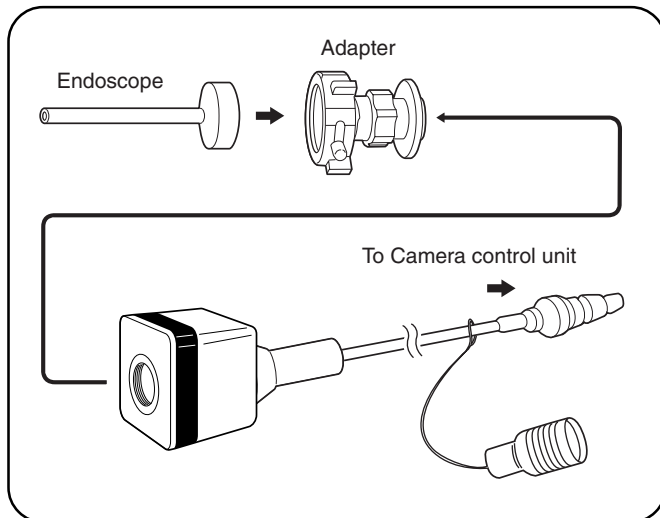

3. When the equipment is purchased, it is not yet sterilized. Endoscope adapter, camera head, and cable, and insulation rubber have to be sterilized at the hospital before use. For the method and condition of sterilization, refer to page 6.
4. The lens of the endoscope adapter may collect moisture due to the difference of inner and outer temperature/humidity. Refer to the operating manual of the endoscope adapter when this problem occurs.

Phenomena peculiar to CCDs

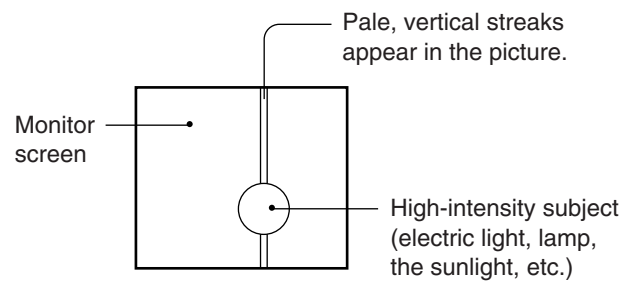

The following CCD-related phenomena may appear on the view screen during shooting.

These are caused by the CCD and are not malfunctions.

Smear phenomenon

Occurs when a high-intensity subject is shot.

Aliasing distortion

Striped patterns or lines appear as jagged patterns.

White or colored luminescent spot

When this unit is operated for a long time under high temperature, a white or colored luminescent spot may appear on the screen. In this case, it is necessary to lower the environmental operating temperature.

When a moving subject is shot, lines and patterns may appear jagged.

Product disposal

Always sterilize the product before disposal (refer to page 6). When disposing the product, environment problems must be taken into consideration, and local regulations and laws pertaining to its handling must be strictly adhered to.

Connections

■ Connection example

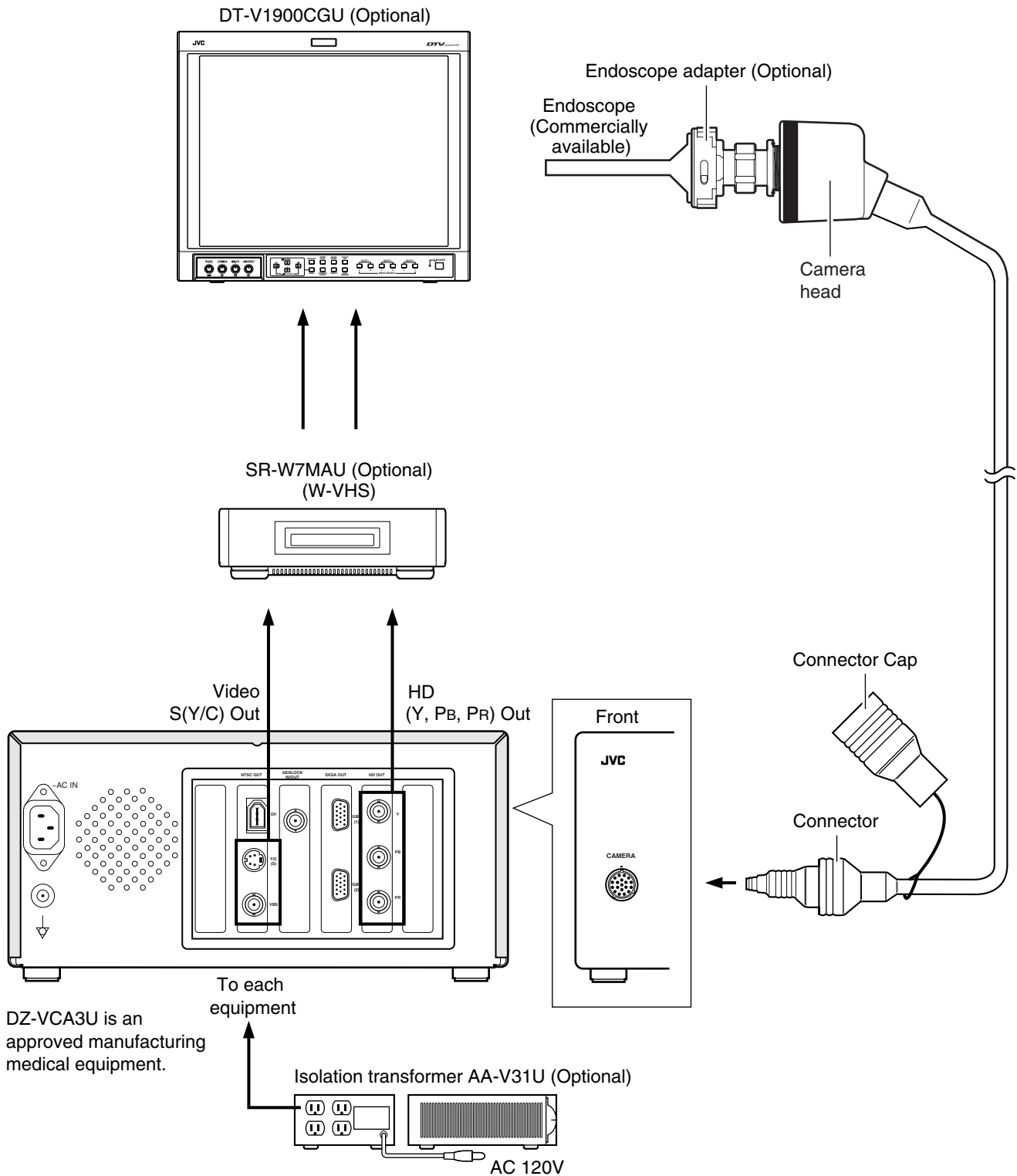

Notes:

- Use the above composition of device or its equivalent.
- Do not connect this camera to equipment other than that depicted in these connection diagrams.
- When the system is connected, check that current leakage from this connection does not surpass the specified level.
- If the exterior of the isolation transformer is corroded, inadequate grounding may result. Have the exterior replaced by your local JVC dealer.

Name of parts and their functions

Camera control unit (front panel)

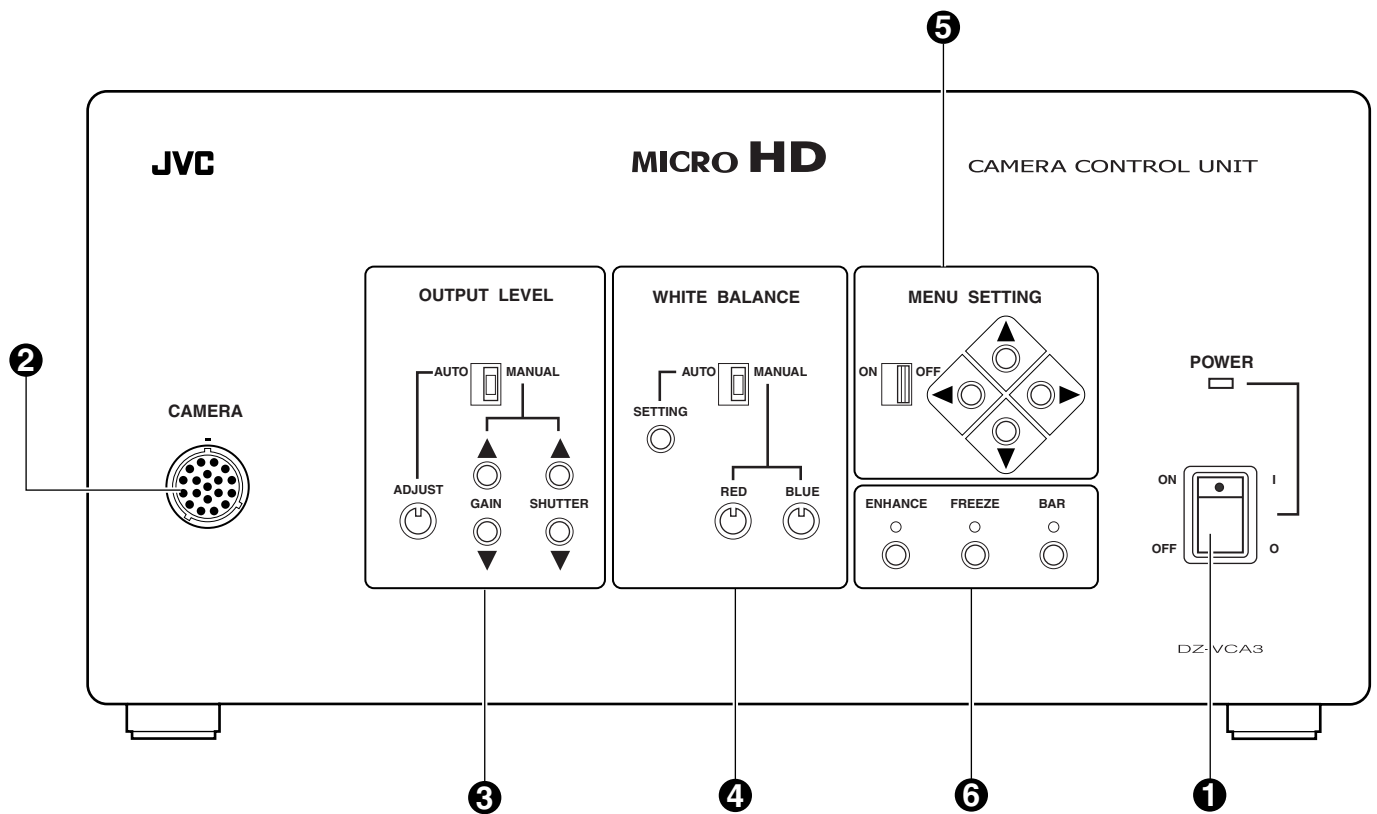

1 [POWER] power switch and power indication LED

When switching power on again after it is just switched off:
Wait for more than 5 seconds before switching it on.

2 [CAMERA] camera cable connector

Connect to camera head.

3 [OUTPUT LEVEL] output level controller section

Set output level automatically or manually.
Set adjustment combining gain and shutter here.

4 [WHITE BALANCE] white balance control section

Adjust white balance automatically or manually

5 Menu control section

Display menu to do various settings.

6 Mode control section

ON/OFF setting of enhance, freeze, and colour bar.

Camera control unit (rear panel)

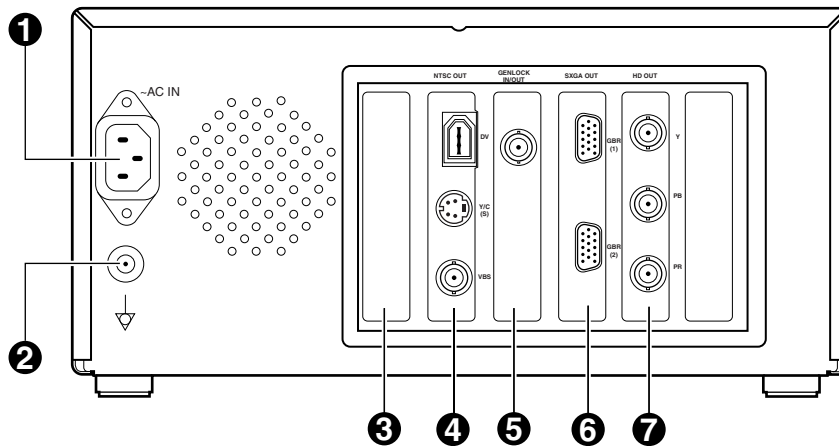

1 [AC INPUT] power input connector

To input AC120V.

2 Equal-potential connector

3 Cover for extension slot

Remove the cover to install an optional device in this slot.

4 [NTSC OUTPUT] NTSC output section

Output of DV signals, Y/C(S) signals, VBS (composite video signals).

The power supply for IEEE1394 interface is not available from DV connector.

5 [GENLOCK IN/OUT] sync signal input/output

Input/output of composite sync signal for external sync. (menu-based switching).

6 [SXGA OUT] SXGA output section

Output of progressive scan GBR signal.

SXGA output signal cannot be displayed on the DT-V1900CGU. Use the monitor that is compliant with the following scanning frequency.

Horizontal: 67.4325kHz, vertical: 59.94Hz

7 [HD OUT] video signal output section

Output of HD (Y, P_B, P_R) video signals (interlace scan).

When HD video signals are connected to Hi-vision monitor, the screen will have a width/length ratio of 16:9, and the picture will extend sideways.

Camera head

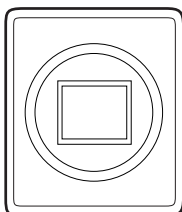

1 Lens mount ring

Standard C mount is used.

Flange back will be 17.526mm in air.

2 Camera cable connector (plug)

Connect to camera control unit.

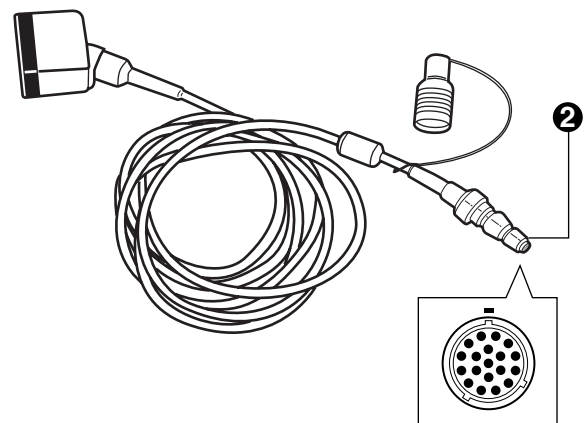

Names of parts and their functions (continued)

Output level control section

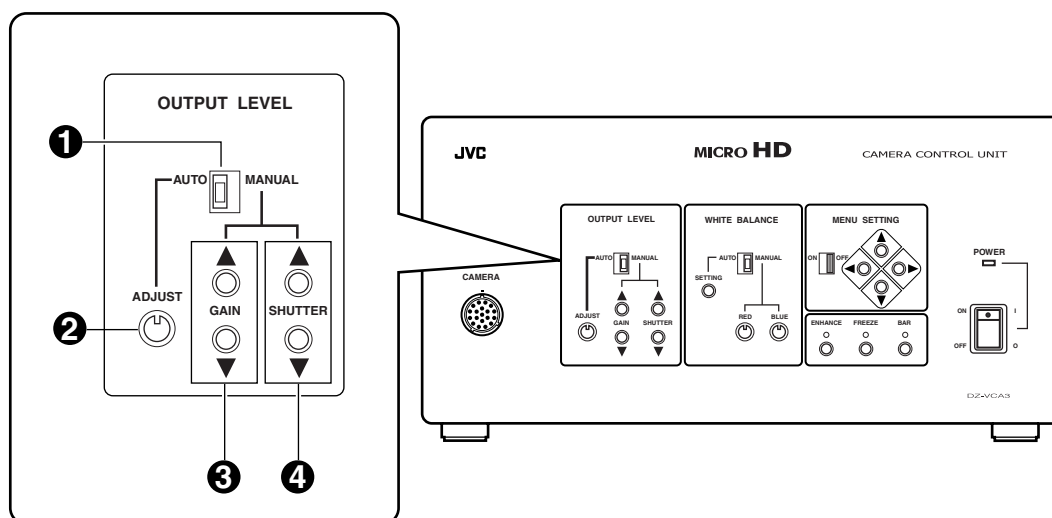

1 GAIN switch

[AUTO]

Adjusts gain automatically.

In this mode, the [GAIN UP]/[GAIN DOWN] button 3 and [SHUTTER UP]/[SHUTTER DOWN] button 4 operations are disabled.

[MANUAL]

Set to this position when adjust the [GAIN] and [SHUTTER] manually.

2 ADJUST volume

Set the brightness during auto sensitivity adjustment.

Enabled only when [GAIN] switch 1 is set to [AUTO].

3 GAIN UP/GAIN DOWN button

[GAIN UP]

Each time this button is pressed, the gain increases by 1 dB.

[GAIN DOWN]

Each time this button is pressed, the gain decreases by 1 dB.

Enabled only when [GAIN] switch 1 is set to [MANUAL].

Setting from -3dB to +24dB is possible.

4 SHUTTER UP/SHUTTER DOWN button

Using the [SHUTTER UP] / [SHUTTER DOWN] button, the following setting is possible: 1/60, 1/100, 1/175, 1/250, 1/375, 1/500, 1/1000, 1/2000, 1/4000, 1/10000.

Enabled only when [GAIN] switch 1 is set to [MANUAL].

Flicker-free mode

Prevents flickering caused by fluorescent lighting in area with 50 Hz.

When the shutter speed is set at 1/100 sec (flicker-free mode), flickering is eliminated.

- When looking at the picture on the monitor while the electronic shutter is being used, the object movement appears to be discontinuous.
For example: in shutter speed of 1/2000 sec. Since the image for 1/2000 sec is taken out every 1/60 sec, this phenomenon occurs.
- When high-speed shutter is used, light may not be sufficient.

White balance control section

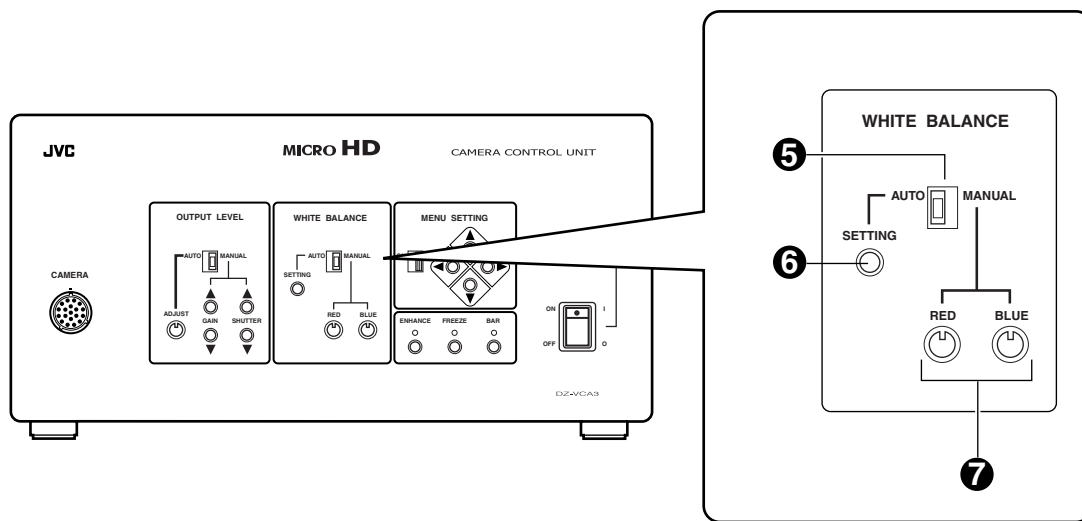

5 WHITE BALANCE switch

[AUTO]

When set to this position, the camera is automatically set to a pre-adjusted white balance.

To automatically readjust the while balance, use [SETTING] button 6.

[MANUAL]

When adjusting the white balance manually, set to this position. Adjustment is done through R/B volume 7.

6 SETTING button

7 R/B button

Names of parts and their functions (continued)

Mode control section

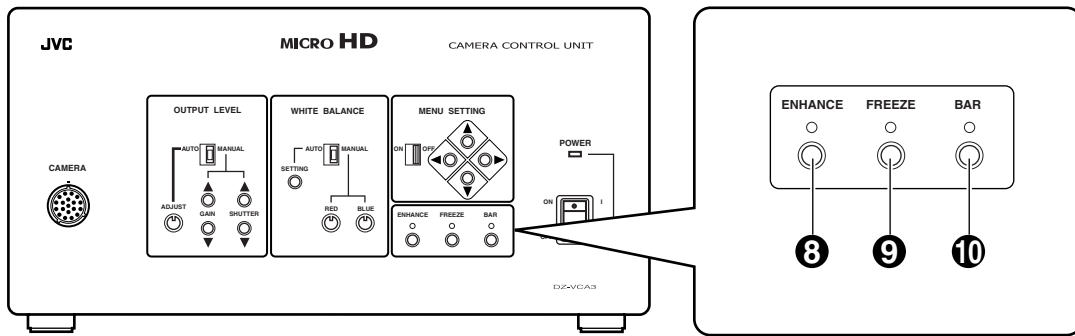

8 ENHANCE button

To set enhance.

By pressing this button, LED will light up, and the enhance already set in the menu will be emphasized. Press it again, then LED and the emphasis will disappear.

10 BAR button

By pressing this button, LED will light up, and Full Color Bar will be displayed. Press it again, then LED will disappear, and camera signal restored.

9 FREEZE button

By pressing this button, LED will light up, and frame Still mode engaged. Press it again, then LED and FREEZE mode will disappear.

Menu control section

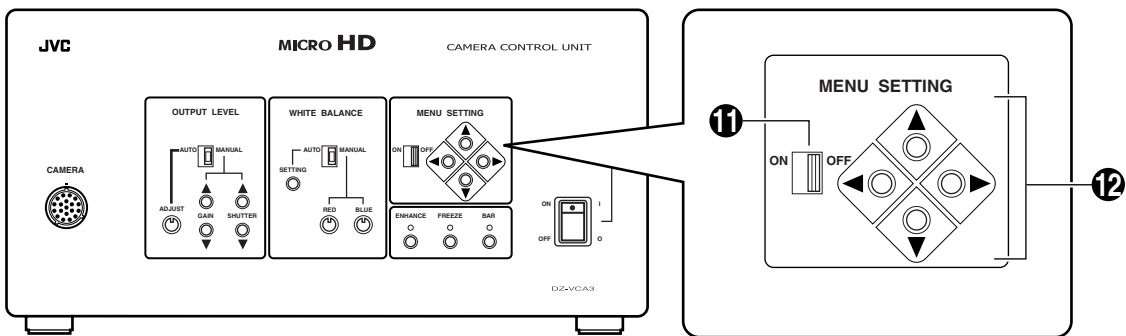

11 MENU switch

[ON]

The menu is displayed on the screen.

Selection of menu item is done with the CURSOR button 12.

[OFF]

The menu is not displayed.

12 CURSOR button

When the mark (.) appears on the left of the menu item, it indicates that the item is selected.

When the up arrow (▲) or down arrow (▼) appears on the left of the menu item, it indicates that the item can be selected with [UP]/[DOWN] CURSOR button.

When the right arrow (▶) or left arrow (◀) appears on the right of the menu item, it indicates that the item can be selected with [LEFT]/[RIGHT] CURSOR button 12.

The menu of this device has 3 screens: PAGE 1-3



■ MENU-PAGE 1

[PAGE] menu

Switch to menu PAGE 1-3 with CURSOR [LEFT]/[RIGHT] button.

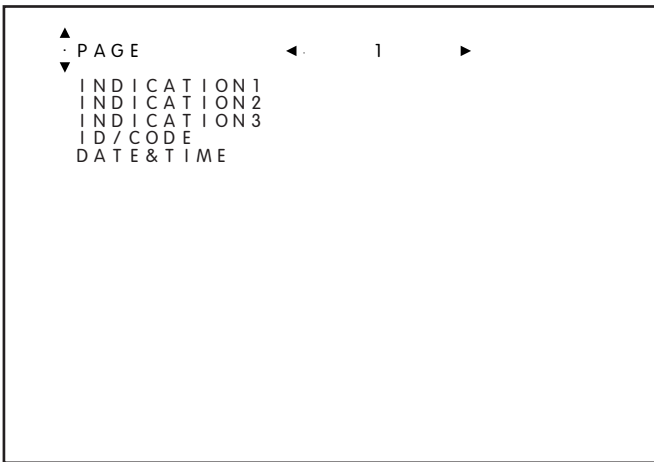

[INDICATION1] menu

Set the display on the top left of HD OUT and SXGA OUT screen.

Selection items and functions are as follows:

Selection items	Functions
ID/CODE	Displays the content set under ID/CODE menu.
GAIN&SHUT	Displays the gain value and shutter value.
OFF	No display

[INDICATION2] menu

Set the display on the top right of HD OUT and SXGA OUT screen.

Selection items and functions are as follows:

Selection item	Function
DATE&TIME	Displays date and time.
TIME	Displays only time.
OFF	No display

[INDICATION3] menu

Set the display on the bottom right of NTSC OUT screen. Selection items and functions are as follows:

Selection item	Function
DATE&TIME	Displays date and time.
TIME	Displays only time.
OFF	No display
TIME&ID/CODE	Displays the content set in time and under ID/CODE menu.
DATE&TIME&ID/CODE	Displays the content set in date and time and under ID/CODE menu.

[ID/CODE] menu

Edit ID/CODE that can be displayed on the screen.

- Select from INDICATION 1, 3 menu to see if it can be displayed.
- Message is up to 24 alphanumeric characters.
- Characters that can be used: A-Z, 0-9, ., :, -, /, and space.

[DATE&TIME] menu

To change date and time setting, and date display format.

[DATE] sub-menu

Use the [LEFT]/[RIGHT] button to select the part of the date to be changed (the numbers will blink), and use the [UP]/[DOWN] button to set the new value.

[TIME] sub-menu

Use the [LEFT]/[RIGHT] button to select the part of the time to be changed (the numbers will blink), and use the [UP]/[DOWN] button to set the new value.

[DATE FORM] sub-menu

Use the [LEFT]/[RIGHT] button to select one of the following three formats:

year, month, day/day, month, year/month, day, year

The month of day, month, year/ month, day, year of HD OUT and SXGA OUT will be displayed in English short form.

Names of parts and their functions (continued)

■ MENU-PAGE 2

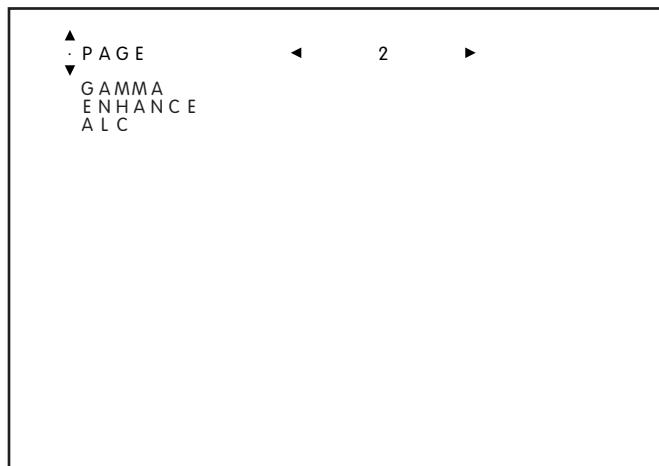

[GAMMA] menu

Select a gamma correction or no gamma correction.

Selected item	Gamma
0.43	$\gamma = 0.43$
0.45	$\gamma = 0.45$
0.47	$\gamma = 0.47$
0.49	$\gamma = 0.49$
OFF	No gamma correction $\gamma = 1.0$

[ENHANCE] menu

Select the contour compensation value or no-contour compensation.

The leftmost on the minus side is the setting for no-contour compensation, and the other 6 levels are for contour compensation.

[ALC] menu

[ZONE] sub-menu

Change the size of the zone where automatic sensitivity control and auto white level detection is performed.

Select [FULL], [LARGE], [MEDIUM], or [SMALL] with [LEFT]/[RIGHT] button.

[DET] sub-menu

Select the level detection method for automatic sensitivity control from peak detection (P), average detection (A), or the combination of both. Use the [LEFT]/[RIGHT] button to select from 5 different levels. The far left is only for peak detection, while the far right is for average detection only. In between there are 3 levels for both peak and average detections.

■ MENU-PAGE 3

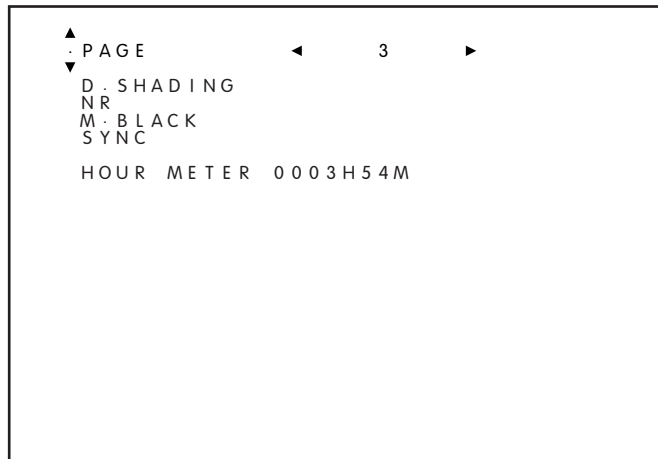

[D.SHADING] menu

For correction of dynamic shading. (colour appearing on the screen in vertical direction.)

No correction at the centre. ± 7 levels of correction is possible.

[GREEN] sub-menu

Increase the green gain at the top of the screen by setting the + side. (Reducing the green gain at the bottom of the screen.)

Reduce the green gain at the top of the screen by setting the - side. (Increasing the green gain at the bottom of the screen.)

[RED] sub-menu

Increase the red gain at the top of the screen by setting the + side. (Reducing the red gain at the bottom of the screen.)

Reduce the red gain at the top of the screen by setting the - side. (Increasing the red gain at the bottom of the screen.)

[NR] menu

To set frame-turning type noise reduction.

HIGH : Large noise reduction effect. (In frequent moving objects, the shadow may be obvious)

LOW : Suppressed noise reduction setting.

OFF : Noise reduction is OFF.

[M.BLACK] menu

Select the master black (setup) value. From the centre with no setup, change of ± 3 steps each side at about 7% step is possible.

[SYNC] menu

Switching between sending GENLOCK basic signal, or input basic signal from other device.

[HOUR METER] display

Indicates accumulated time of power usage. It cannot be selected with cursor.

Basic operation

White balance adjustment

● AUTO

SETTING button

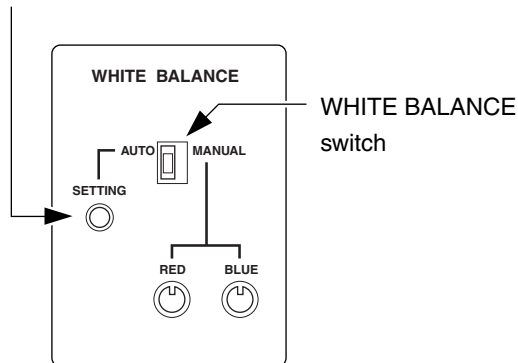

While watching the monitor, shoot a white object with full screen under the same lighting condition as actual shooting.

Set the WHITE BALANCE switch to [AUTO].

When you press and hold [SETTING] button, [AUTO WHITE] will blink at the upper left corner of the screen.

When white balance adjustment is complete, the indication changes to [AUTO WHITE OK].

If the indication at the upper left corner of the monitor screen does not change to [AUTO WHITE OK], it means white balance adjustment has not been completed.

Check the following items, and retry auto white balance adjustment.

1. Is lighting sufficient? (Adjust the lighting.)
Or is lighting too bright ?
2. Did you shoot a coloured object? (Shoot a white object.)

● MANUAL

WHITE BALANCE switch

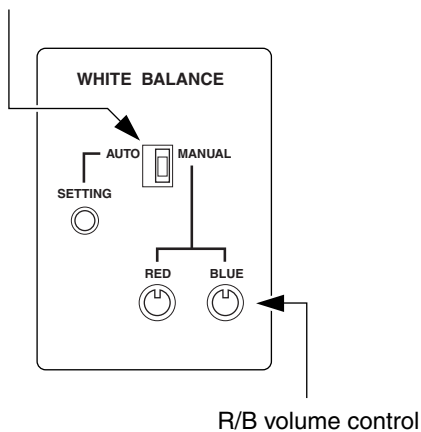

Connect a measuring instrument such as a waveform monitor to the HD output jack, and adjust the white balance while watching the waveform.

First, set the WHITE BALANCE switch to [MANUAL].

Adjust P_B and P_R output amplitudes to the minimum with [R]/[B] volume controls.

Adjust P_R with [R] volume control, and P_B with [B] volume control.

If measuring instrument is not available, adjust the picture on the monitor screen until it turns white. In this case, high-precision white balance cannot be obtained.

Basic operation (Continued)

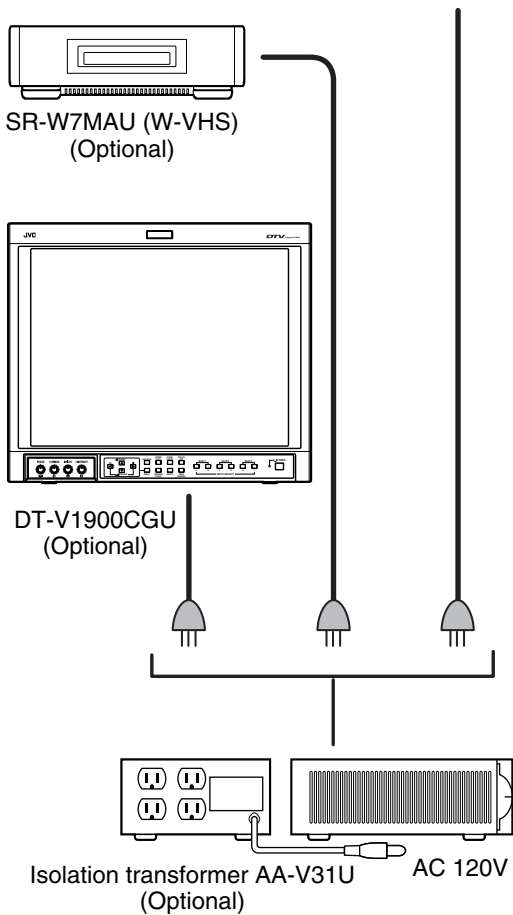
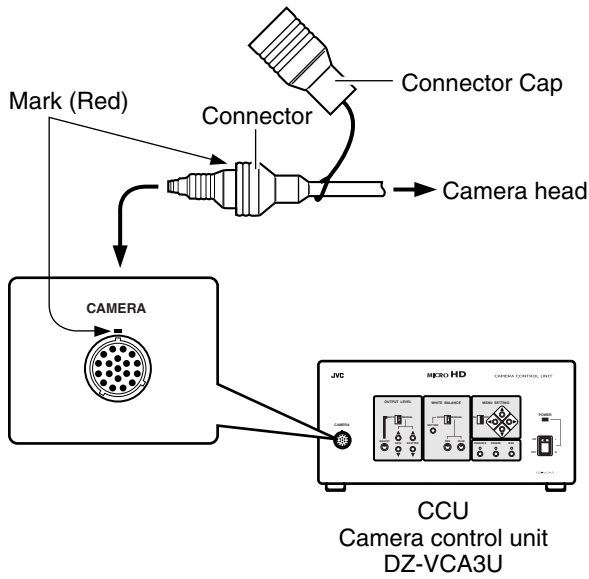

Operation of Micro HD camera

Check system operation according to the following procedures.

1. Insert the camera connector while aligning it to the red mark as shown on the left figure.
When cap is connected to the camera connector:
Turn the cap counterclockwise to remove it.
2. Connect the endoscope adapter to the C mount of camera head.
3. Connect the power plug directly to the wall outlet of the operating room.
4. When operating this system, set the switches on the CCU panel as follows:
 - 1) OUTPUT LEVEL : [AUTO]
 - 2) WHITE BALANCE : [AUTO]
 - 3) MENU SETTING : [OFF]
5. Switch on the CCU.
6. Adjust the white balance.

System operation

Check system operation according to the following procedures.

1. Insert the camera connector while aligning it to the red mark as shown on the left figure.
When cap is connected to the camera connector:
Turn the cap counterclockwise to remove it.
2. When the camera is used as a system, connect the power plugs of the camera and other equipments to the isolation transformer AA-V31U.
3. Switch on isolation transformer AA-V31U power switch.
4. Switch on W-VHS power.
Insert W-VHS tape, and make sure that it can record.
5. Switch on the power of monitor.
At CCU front panel mode selection, set it to "Camera".
Then check that picture taken by camera can be displayed on the monitor.
6. Operate each device according to its operating procedure.

Note : Consult JVC service personnel or authorized dealer when connecting the system for the first time.
Do not disconnect, or modify the connection by yourself.

Connector

● Camera head input/output connector

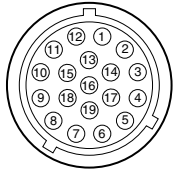

1. Sync signal output
2. Sync signal output
3. Shutter speed control signal
4. Shutter speed control signal
5. Shutter speed control signal
6. Control signal input
7. DC 15V output
8. DC 5V output
9. GND
10. -7.5V output
11. B signal input
12. GND
13. G signal input
14. GND
15. R signal input
16. GND
17. Basic clock input
18. GND
19. NC

Symbols indicated on this equipment have the following meanings

	Attention, consult ACCOMPANYING DOCUMENTS		Equipotentiality
	Alternating current		Protective earth (ground)
	Off (power: disconnection from the mains)		Earth (ground)
	On (power: connection to the mains)		CLASS II EQUIPMENT
	TYPE OF APPLIED CF EQUIPMENT		Video output

Specifications

Design and specifications subject to change without notice.

MICRO HD CAMERA DZ-VCA3U

Camera head section

■ Image sensing device	: 1/3-inch PS-CCD (350,000 pixels)
■ Shooting system	: 3-CCD system
■ Color separation optical system	: 1/3 type F1.4 3-color separation prism
■ Number of effective pixels	: 659 (horizontal) x 494 (vertical), 330,000 pixels approximately
■ Camera output	: 19 pins
■ Lens mount	: Standard mount (flange back: 17.526 mm in air)
■ Dimensions	: Camera head; 44 (W) x 51.4 (H) x 57.7 (D) mm (1-6/8" x 2-1/16" x 2-2/8") (not including protrusion and camera cable etc)
■ Weight	: Camera head; 100 g (0.22 lbs.)
■ Classification	: Type CF applied part

Camera control unit section

■ Number of scanning lines	: 1125 (980 effective)
■ Scanning system	: 2:1 interlace (HD OUT, NTSC OUT) Progressive (SXGA OUT)
■ Scanning frequency	: HD OUT 33.71625kHz (horizontal), 59.94 Hz (vertical) SXGA OUT 67.4325kHz(horizontal), 59.94 Hz (vertical) NTSC OUT 15.73425kHz(horizontal), 59.94 Hz (vertical)
■ Aspect ratio	: 4:3
■ Horizontal resolution (center)	: 750 TV lines TYP. (Y signal)
■ Vertical resolution (center)	: 700 TV lines TYP. (Y signal)
■ S/N	: 52dB
■ Sensitivity	: F6.8, 2000 lx
■ Minimum subject illuminance	: 5 lx
■ Sync system	: Internal sync/external sync
■ External sync signal input	: Composite sync signal of ± 0.3 Vp-p, 75 ohms, BNC x 1 (BTA S-001 HDTV standard compliant)
■ Color bar	: Full color bar
■ Contour correction	: Horizontal dual-edged (7-step variable) Vertical dual-edged (7-step variable)
■ Electronic shutter speed	: 1/60 s (normal), 1/100 s (flicker-free), 1/175 s, 1/250 s, 1/375 s, 1/500 s, 1/1000 s, 1/2000 s, 1/4000s, 1/10000s
■ Video output	
• SXGA signal	: R/G/B 0.7 Vp-p, 75 ohms HD/VD TTL D-Sub mini 15 pin
• HD signal	: Y 1 Vp-p Pb/Pr 0.7 Vp-p 75 ohms BNC x 3
• NTSC signal	: VBS 1 Vp-p 75 ohms BNC Y/C 1 Vp-p 75 ohms S terminal
• DV signal	: IEEE1394 6 pins
■ Camera input	: 19 pins
■ Date indication	: Menu system 1) Year, month, day 2) Day, month, year 3) Month, day, year
■ Time indication	: Menu system, hour : minute: second
■ Rating	: 120V AC 0.7A 60Hz
■ Classification of insulation	: Class I
■ Operating environment	: +5°C to +35°C (41°F to 95°F), 35 – 75%
■ Storage environment	: -20°C to +50°C (-4°F to 102°F), 35 – 80%
■ Dimensions	: 280 (W) x 140 (H) x 300.6 (D) mm (11-3/16" x 5-9/16" x 11-13/16") (excluding the protrusion and switches etc)
■ Weight	: 5.5 kg (12.1 lbs.)
■ Accessories	: Power cord x 1 Instruction manual x 1 Warranty card x 1

Outer dimensions

Camera head

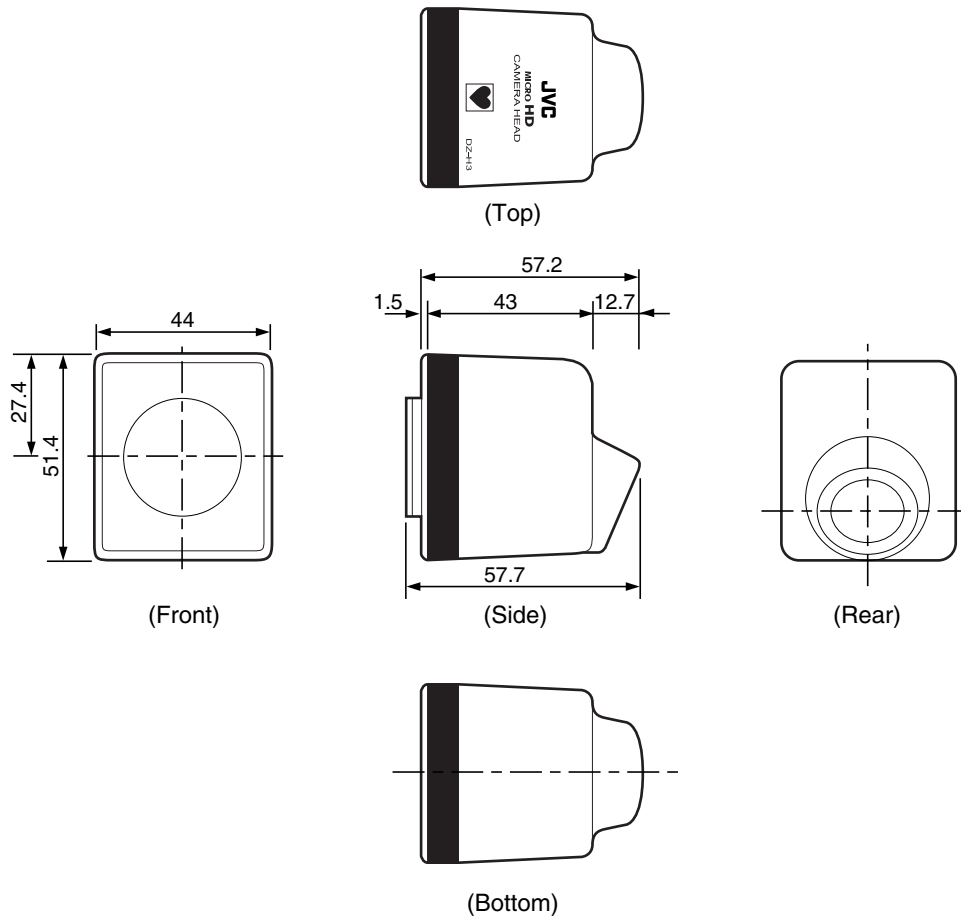

Camera control unit

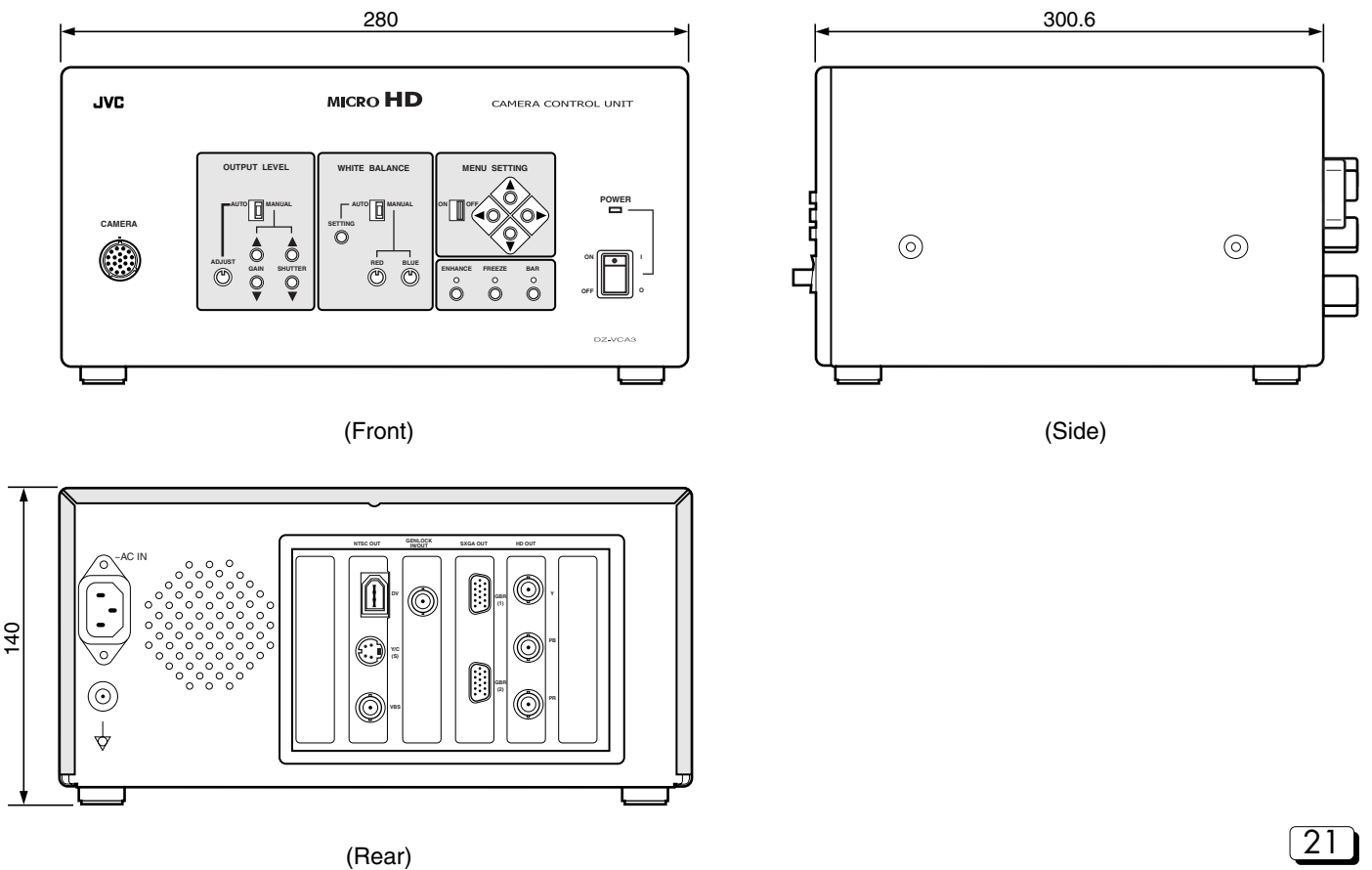

Optional Equipments

Isolation transformer AA-V31U

- Input : 120 V AC 3.1 A 60 Hz
- Output : 120 V AC 3.0 A 60 Hz
- Weight : 6.7kg
- Accessories : Plug retainer bracket x 3
Torx head screw x 8
Cover plate x 3
Flat washer x 3
Split locking washer x 3

HD monitor DT-V1900CGU

- Power requirements : 120 V AC 60 Hz
- Power consumption : 1.6 A
- Dimensions : 476 mm (W) x 407.5 mm (H) x
529 mm (D)
- Weight : 31.6 kg

W-VHS VCR SR-W7MAU

- Power requirements : 120 V AC 60 Hz
- Power consumption : 43W
- Dimensions : 476 mm (W) x 148 mm (H) x
366 mm (D)
- Weight: : 10 kg

Endoscope Adapter DZ-E3U

- Focal length : 24 mm
- Camera Mount : C-Mount
- Sterilization : Applicable for STERAD®, and Steris
processing.
- Weight : 51g (1.8 oz)

Zoom endoscope adapter DZ-E33U

- Focal length : 13mm to 26mm
- Camera Mount : C-Mount
- Sterilization : Applicable for STERAD®, and Steris
processing.
- Weight : 102g (3.6 oz)

TECHNICAL AND SERVICE ASSISTANCE

JVC offers technical and customer service assistance.
Please contact us at the following address.

Importer's name & address

J.P.C.: JVC PROFESSIONAL PRODUCTS COMPANY
1700 Valley Road, Wayne NJ 07470
TEL: (973) 317-5000
FAX: (973) 317-5030

Warranty and after-sales-service

Warranty record confirmation and safekeeping

This product is sold with a warranty card attached.

Warranty card has been delivered to sales dealer of this product. Please check your particulars and the record after filling, and keep it properly.

■ Warranty period:

Warranty period is one year from the date of purchase.

Thereafter, service will be chargeable.

Servicing will be done by sales dealer based on record written in warranty card.

However, compensation other than service guarantee will not be entertained.

Business opportunity loss due to damage will not be entertained.

For further details, please refer to warranty card.

■ Servicing after expiry of warranty period:

Please consult sales dealer for servicing after expiry of warranty period.

In the case of maintaining function through service, servicing will be performed according to the wish of customer and it will be chargeable.

■ After-sales-service inquiry counter

For after-sales-service inquiry, consult sales dealer or nearest service counter listed in Service Counter Guides.

■ Escape clause

1. Using this product for medical treatment is the decision and responsibility of medical doctors. Our company is not responsible for treatment result using this product.
2. Our company is not responsible for any damage to this product due to removal, servicing, inspection, and modification unless it is handled by our company or authorized dealer.
3. During delivery or redelivery of this product, the responsibility to sterilize it belongs to the doctor or the hospital. Our company is not responsible if this product becomes a medium in transmitting bacteria to doctors, technicians, nurses, patients, etc.
4. Our company is not responsible for the use of this product, and the performance of this product when, during its use, natural disaster such as earthquake, fire, or electric power shutdown occurs. Concerning backup and others, they are solely the responsibility of the doctors or the hospital.
5. Our company is not responsible for the result of using this product if the warnings and operating methods printed in this Instruction Manual are not followed.

DZ-VCA3U

